

1. *Dimensions for reference*
2. *Delivery and packaging are carried out in accordance with the terms of the contract*
3. *The manufacturer reserves the right, without notice to the consumer, to make changes to the design of the products for improvement of their technological and operational parameters, which will not affect the quality and properties of the product*
4. *Deviation of the actual weight of the nominal can be up to 10%.*

UNLESS OTHERWISE SPECIFIED: DIMENSIONS ARE IN MILLIMETERS SURFACE FINISH: TOLERANCES: ISO 2768 - C LINEAR: ANGULAR:				FINISH:		DEBURR AND BREAK SHARP EDGES		DO NOT SCALE DRAWING		REVISION	
											
								TITLE: Polymer Concrete End Cap for Polymer Concrete Channel Base DN100 H60			
								ARTICLE: 670127/60		A3	
						MATERIAL: Polymer Concrete		SCALE:1:1		SHEET 1 OF 1	
						WEIGHT: 0.22 kg					
DRAWN		NAME		SIGNATURE		DATE					
		Kozak				06.04.23					
CHK'D		Kyselytsia									
APPV'D		Malynovskiy									
MFG											
Q.A											

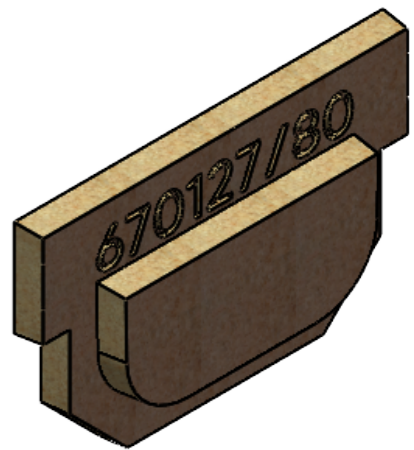
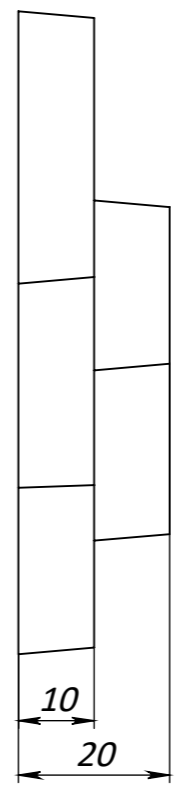
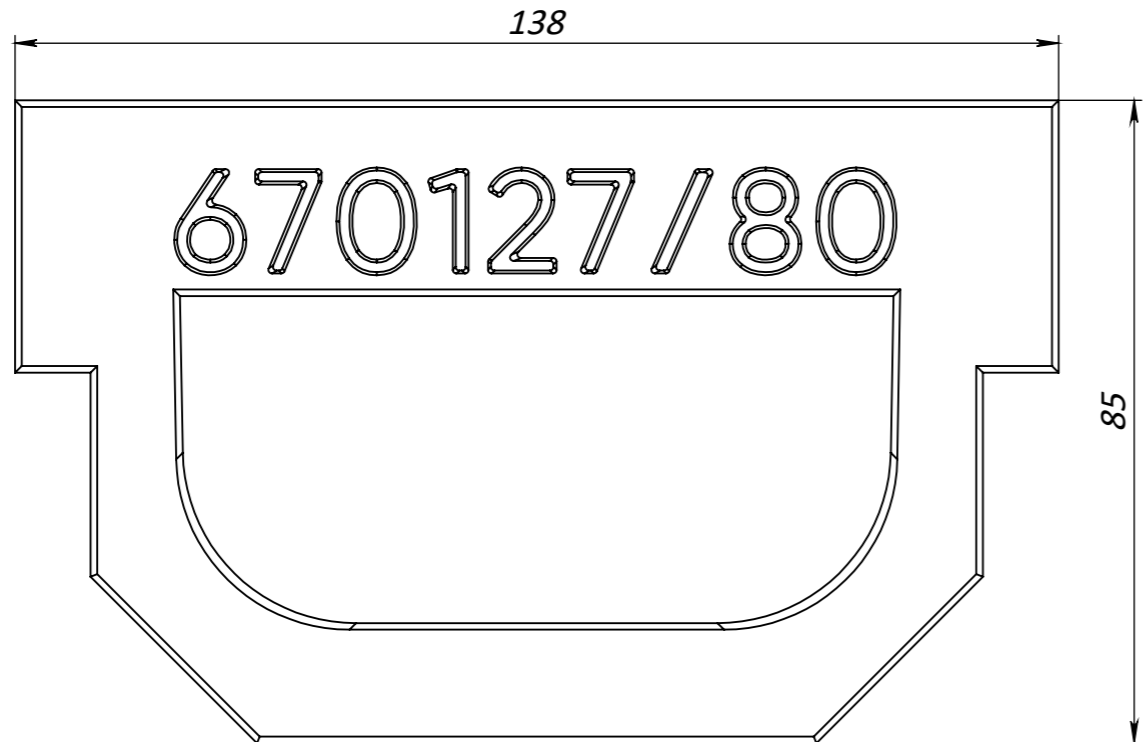

1. *Dimensions for reference*
2. *Delivery and packaging are carried out in accordance with the terms of the contract*
3. *The manufacturer reserves the right, without notice to the consumer, to make changes to the design of the products for improvement of their technological and operational parameters, which will not affect the quality and properties of the product*
4. *Deviation of the actual weight of the nominal can be up to 10%.*

UNLESS OTHERWISE SPECIFIED: DIMENSIONS ARE IN MILLIMETERS SURFACE FINISH: TOLERANCES: ISO 2768 - C LINEAR: ANGULAR:		FINISH:		DEBURR AND BREAK SHARP EDGES		DO NOT SCALE DRAWING		REVISION	
DRAWN		NAME		SIGNATURE		DATE		TITLE:	
CHK'D		Kozak				06.04.23		Polymer Concrete End Cap for Polymer Concrete Channel Base DN100 H80	
APPV'D		Kyselytsia							
MFG		Malynovskiy							
Q.A									
						MATERIAL: Polymer Concrete		ARTICLE: 670127/80	
						WEIGHT: 0.30 kg		SCALE: 1:1	
								SHEET 1 OF 1	
								A3	

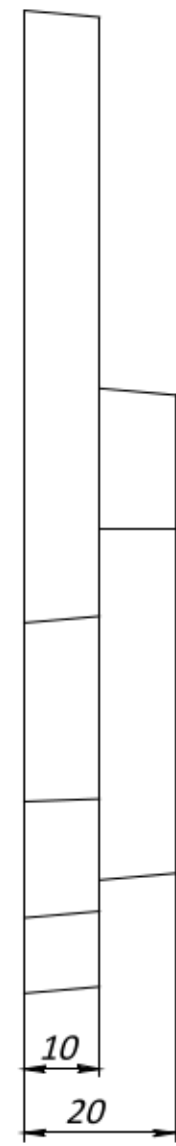
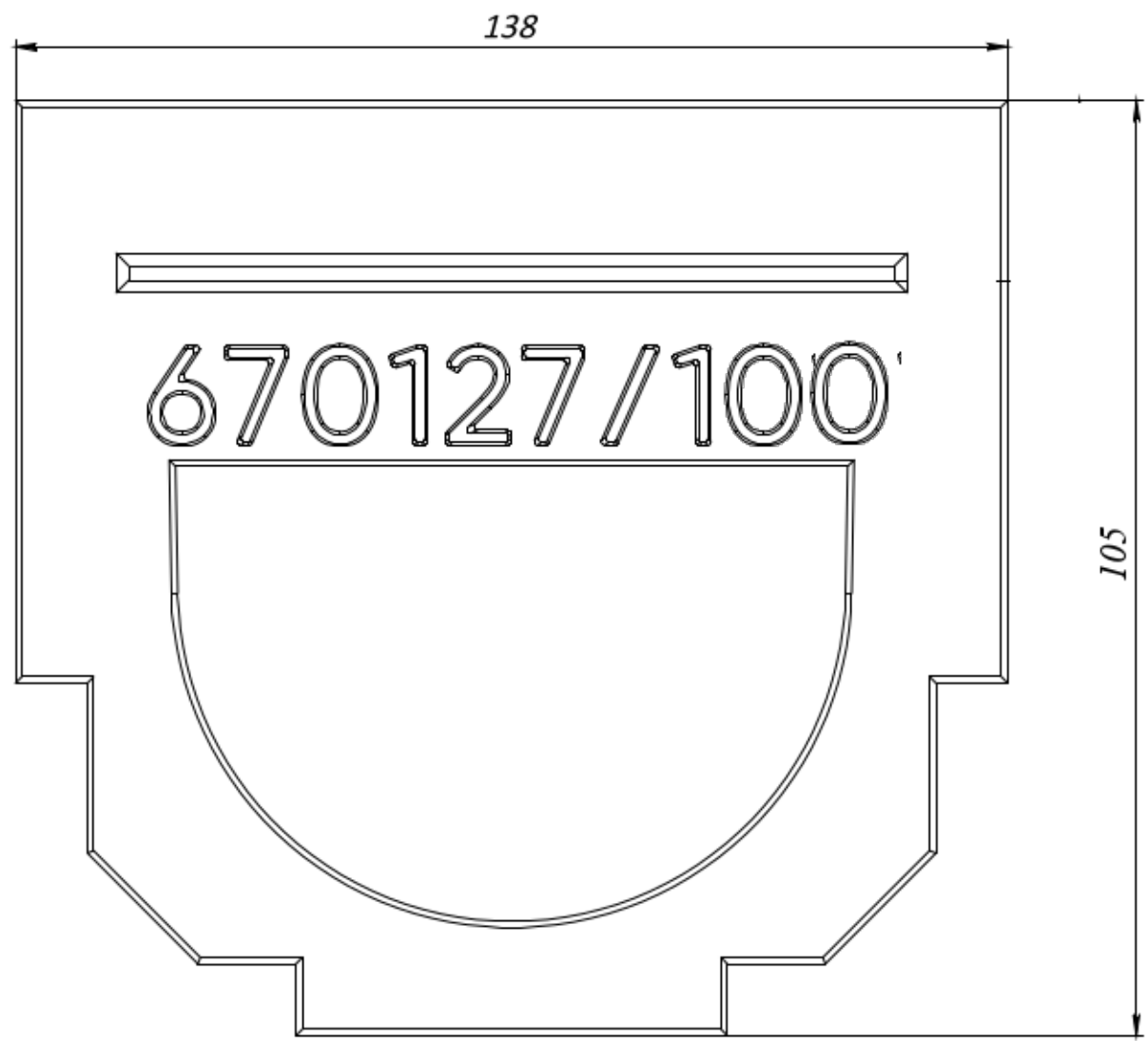

1. *Dimensions for reference*
2. *Delivery and packaging are carried out in accordance with the terms of the contract*
3. *The manufacturer reserves the right, without notice to the consumer, to make changes to the design of the products for improvement of their technological and operational parameters, which will not affect the quality and properties of the product*
4. *Deviation of the actual weight of the nominal can be up to 10%.*

UNLESS OTHERWISE SPECIFIED: DIMENSIONS ARE IN MILLIMETERS SURFACE FINISH: TOLERANCES: ISO 2768 - C LINEAR: ANGULAR:		FINISH:	DEBURR AND BREAK SHARP EDGES	DO NOT SCALE DRAWING	REVISION
DRAWN: Kozak		SIGNATURE:	DATE: 06.04.23	 TITLE: Polymer Concrete End Cap for Polymer Concrete Channel Base DN100 H100 ARTICLE: 670127/100 A3	
CHK'D: Kyselytsia					
APPV'D: Malynovskiy					
MFG:					
QA:					
		MATERIAL: Polymer Concrete		SCALE: 1:1	
		WEIGHT: 0.45 kg		SHEET 1 OF 1	

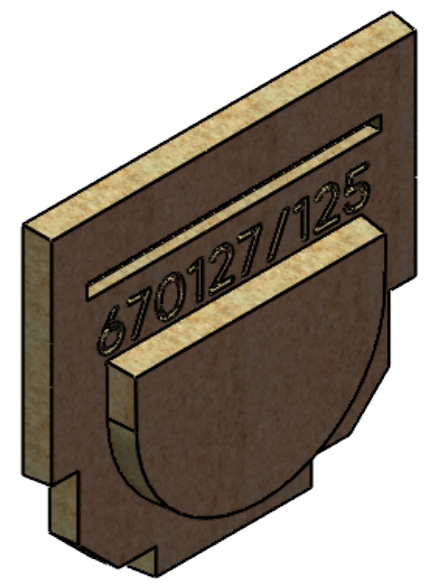
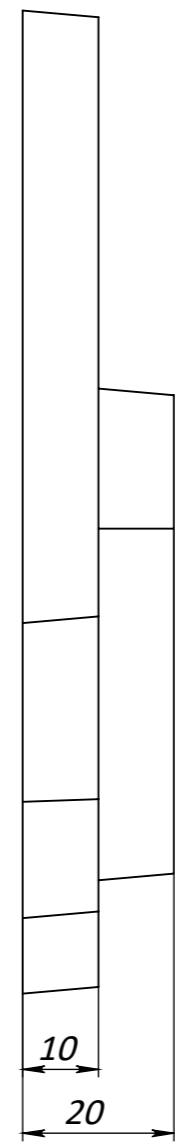
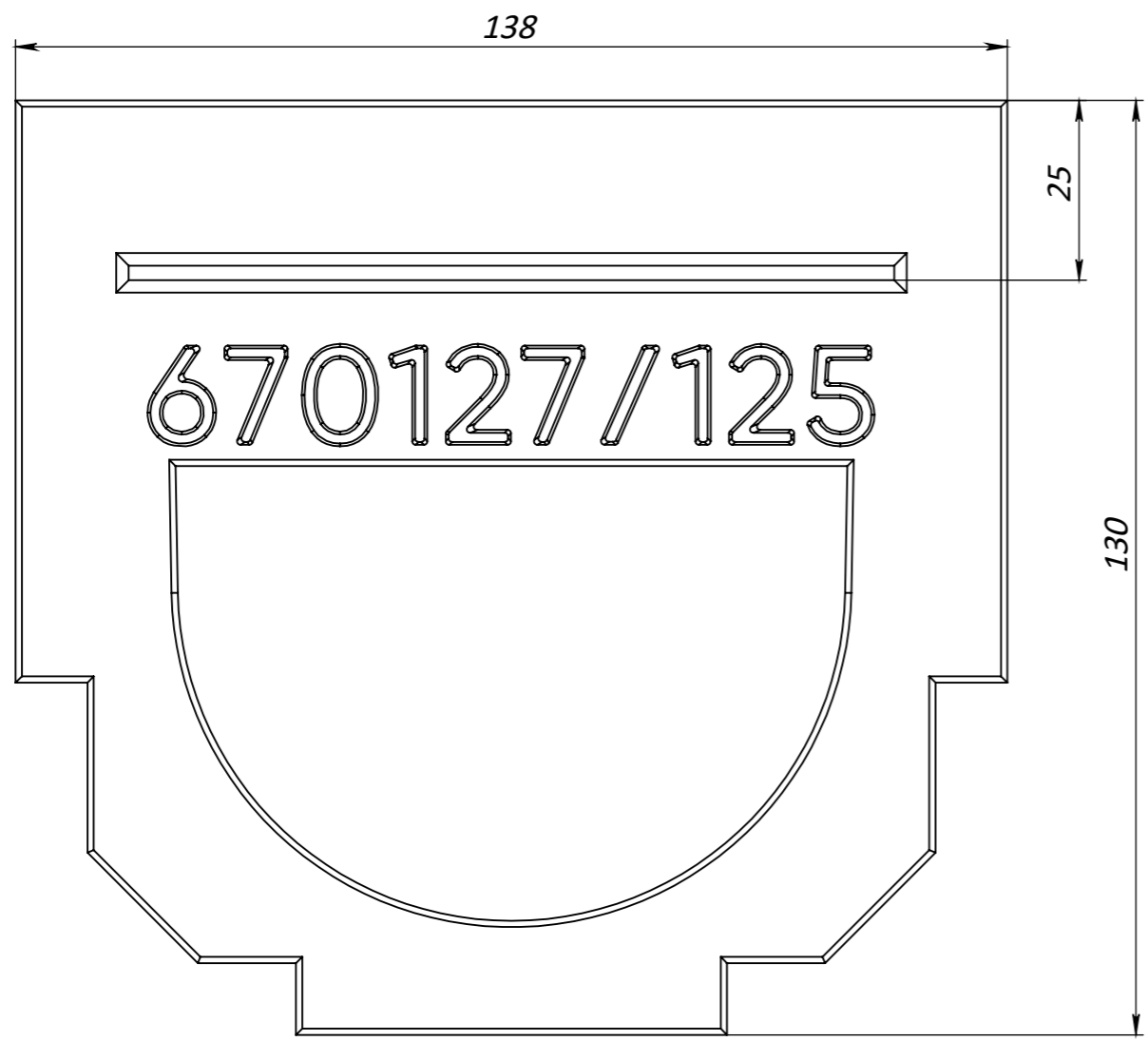

1. *Dimensions for reference*
2. *Delivery and packaging are carried out in accordance with the terms of the contract*
3. *The manufacturer reserves the right, without notice to the consumer, to make changes to the design of the products for improvement of their technological and operational parameters, which will not affect the quality and properties of the product*
4. *Deviation of the actual weight of the nominal can be up to 10%.*

UNLESS OTHERWISE SPECIFIED: DIMENSIONS ARE IN MILLIMETERS SURFACE FINISH: TOLERANCES: ISO 2768 - C LINEAR: ANGULAR:		FINISH:		DEBURR AND BREAK SHARP EDGES		DO NOT SCALE DRAWING		REVISION	
DRAWN		NAME		SIGNATURE		DATE		TITLE:	
CHK'D		Kozak				06.04.23		Polymer Concrete End Cap for Polymer Concrete Channel Base DN100 H125	
APPV'D		Kyselytsia						ARTICLE:	
MFG		Malynovskiy						670127/125	
Q.A								A3	
						MATERIAL: Polymer Concrete		SCALE:1:1	
						WEIGHT: 0.45 kg		SHEET 1 OF 1	

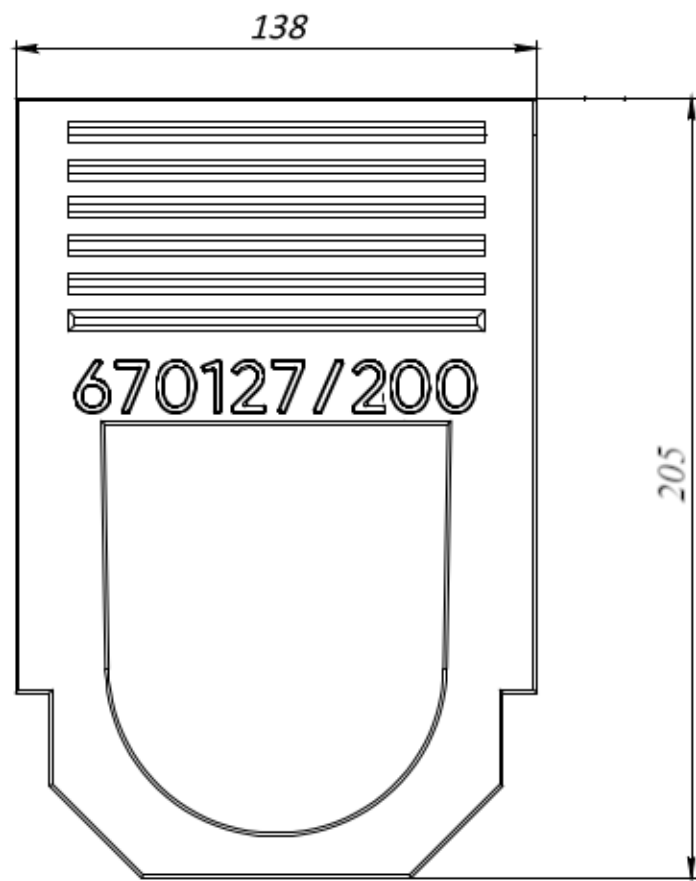

1. Dimensions for reference
2. Delivery and packaging are carried out in accordance with the terms of the contract
3. The manufacturer reserves the right, without notice to the consumer, to make changes to the design of the products for improvement of their technological and operational parameters, which will not affect the quality and properties of the product
4. Deviation of the actual weight of the nominal can be up to 10%.

UNLESS OTHERWISE SPECIFIED: DIMENSIONS ARE IN MILLIMETERS SURFACE FINISH: TOLERANCES: ISO 2768 - C LINEAR: ANGULAR:		FINISH:		DEBURR AND BREAK SHARP EDGES		DO NOT SCALE DRAWING		REVISION	
DRAWN		NAME		SIGNATURE		DATE		TITLE:	
CHK'D		Kozak				06.04.23		Polymer Concrete End Cap for Polymer Concrete Channel Base DN100 H200	
APPV'D		Kyselytsia						ARTICLE:	
MFG		Malynovskiy						670127/200	
QA						MATERIAL:		A3	
						Polymer Concrete		SCALE:1:2	
						WEIGHT: 0.86 kg		SHEET 1 OF 1	

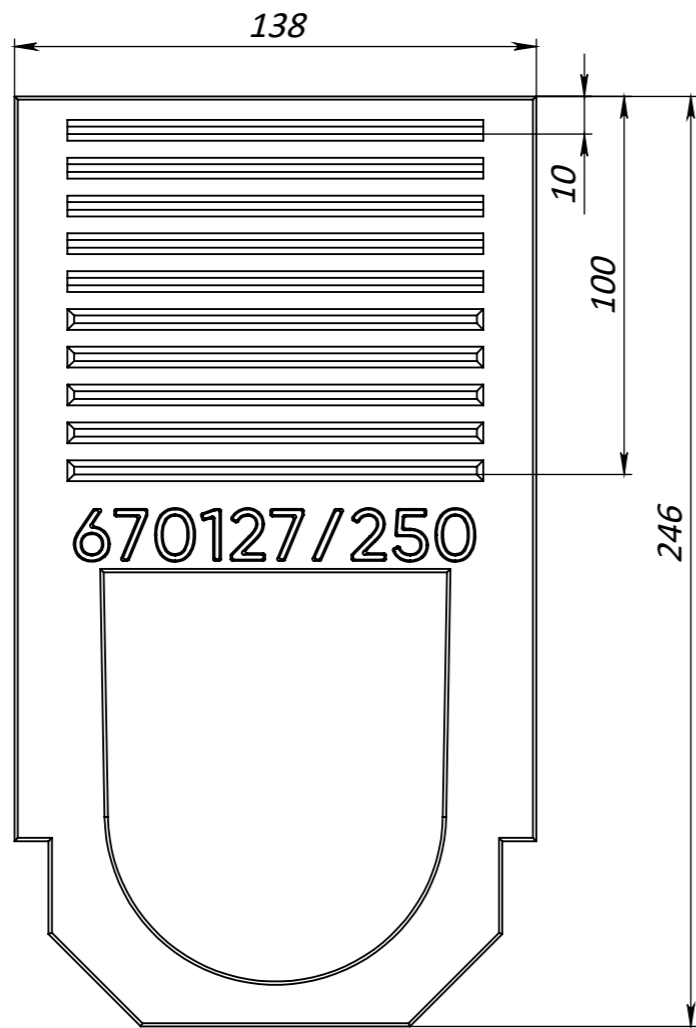

1. *Dimensions for reference*
2. *Delivery and packaging are carried out in accordance with the terms of the contract*
3. *The manufacturer reserves the right, without notice to the consumer, to make changes to the design of the products for improvement of their technological and operational parameters, which will not affect the quality and properties of the product*
4. *Deviation of the actual weight of the nominal can be up to 10%.*

UNLESS OTHERWISE SPECIFIED: DIMENSIONS ARE IN MILLIMETERS SURFACE FINISH: TOLERANCES: ISO 2768 - C LINEAR: ANGULAR:			FINISH:		DEBURR AND BREAK SHARP EDGES		DO NOT SCALE DRAWING		REVISION		
											
DRAWN			NAME		SIGNATURE		DATE		TITLE:		
			Kozak				06.04.23		Polymer Concrete End Cap for Polymer Concrete Channel Base DN100 H250		
CHK'D			Kyselytsia						ARTICLE: 670127/250		
APPV'D			Malynovskiy								
MFG											
Q.A									MATERIAL: Polymer Concrete		A3
									WEIGHT: 0.86 kg		SHEET 1 OF 1
									SCALE: 1:2		